



Pressure Reducing Valve

- Flow and leakage reduction
- Cavitation damage protection
- Throttling noise reduction
- Burst protection
- System maintenance savings

The Model 720 Pressure Reducing Valve is a hydraulically operated, diaphragm actuated control valve that reduces higher upstream pressure to lower constant downstream pressure regardless of fluctuating demand or varying upstream pressure.



Features and Benefits

- **Line pressure driven** – Independent operation
- **In-line serviceable** – Easy maintenance
- **Double chamber design**
 - Moderated valve reaction
 - Protected diaphragm
- **Flexible design** – Easy addition of features
- **Variety of accessories** – Perfect mission matching
- **"Y" or angle, wide body** – Minimized pressure loss
- **Semi-straight flow** – Non-turbulent flow
- **Stainless Steel raised seat** – Cavitation damage resistant
- **Obstacle free, full bore** – Uncompromising reliability
- **V-Port Throttling Plug** – Low flow stability

Major Additional Features

- UL Listed for fire protection – **FP-720-UL**
- Solenoid control – **720-55**
- Check valve – **720-20**
- Solenoid control & check valve – **720-25**
- Proportional – **720-PD**
- Automatic regulation override – **720-09**
- High sensitivity pilot – **720-12**
- Emergency pressure reducing valve – **720-PD-59**
- Downstream over pressure guard – **720-48**
- Electrically selected multi-level setting – **720-45**
- Electronic multi-level setting, Type 4T – **720-4T**
- Electronic pressure reducing valve – **728-03**

See relevant BERMAD publications.



Operation

The Model 720 is a pilot controlled valve equipped with an adjustable, 2-Way pressure reducing pilot.

The needle valve [1] continuously allows flow from the valve inlet into the upper control chamber [2]. The pilot [3] senses downstream pressure.

Should this pressure rise above pilot setting, the pilot throttles, enabling pressure in the upper control chamber to accumulate, causing the main valve to throttle closed, decreasing downstream pressure to pilot setting.

Should downstream pressure fall below pilot setting, the pilot releases accumulated pressure, and the main valve modulates open.

The integral orifice between the lower control chamber and valve outlet moderates valve reactions.

The needle valve controls the closing speed. The downstream cock valve [4] enables manual closing.

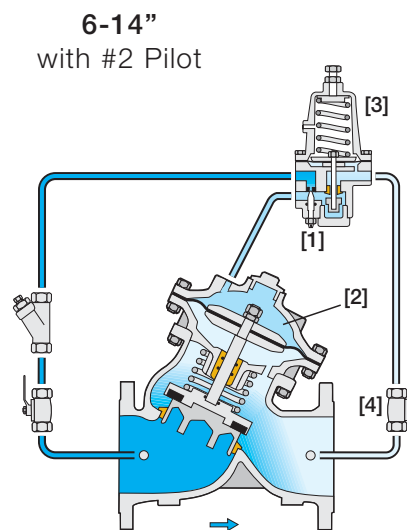
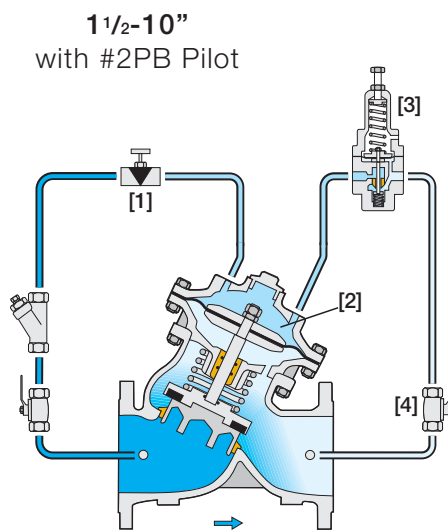

Note: For 16" and larger valves, see "Pilot Valve Selection" table at the last page.

Engineer Specifications

The Pressure Reducing Valve shall reduce higher upstream pressure to lower preset downstream pressure regardless of fluctuating demand or varying upstream pressure.

Main Valve: The main valve shall be a center guided, diaphragm actuated globe valve of either oblique (Y) or angle pattern design. The body shall have a replaceable, raised, stainless steel seat ring. The valve shall have an unobstructed flow path, with no stem guides, bearings, or supporting ribs. The body and cover shall be ductile iron. All external bolts, nuts, and studs shall be Duplex® coated. All valve components shall be accessible and serviceable without removing the valve from the pipeline.

Actuator: The actuator assembly shall be double chambered with an inherent separating partition between the lower surface of the diaphragm and the main valve. The entire actuator assembly (seal disk to top cover) shall be removable from the valve as an integral unit. The stainless steel valve shaft shall be center guided by a bearing in the separating partition. The replaceable radial seal disk shall include a resilient seal and shall be capable of accepting a V-Port Throttling Plug by bolting.

Control System: The control system shall consist of a 2-Way adjustable, direct acting, pressure reducing pilot valve, a needle valve, isolating cock valves, and a filter. All fittings shall be forged brass or stainless steel. The assembled valve shall be hydraulically tested and factory adjusted to customer requirements.

Quality Assurance: The valve manufacturer shall be certified according to the ISO 9001 Quality Assurance Standard. The main valve shall be certified as a complete drinking water valve according to NSF, WRAS, and other recognized standards.



Typical Applications

Pressure Reducing System for Municipal Networks

Network design requires establishing various pressure zones due to topography, distances, demands, energy costs, reservoir availability, etc.

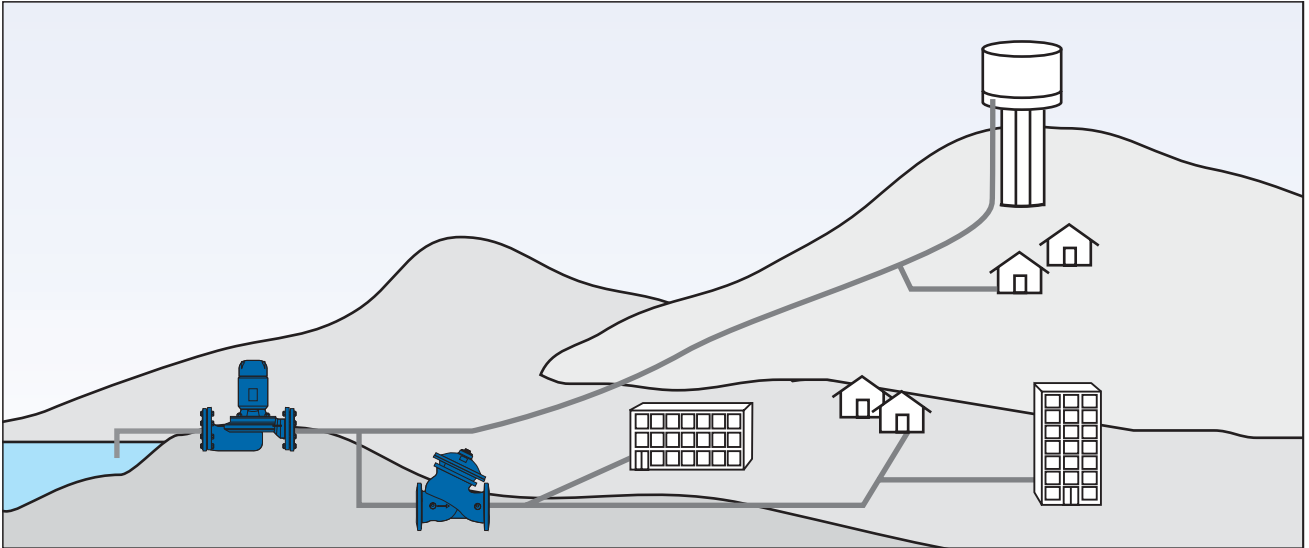

The pump supplies water to the network and to the reservoir. System pressure is too high for the residential neighborhood, requiring a pressure reducing system.

Pressure Reducing System – Typical Installation

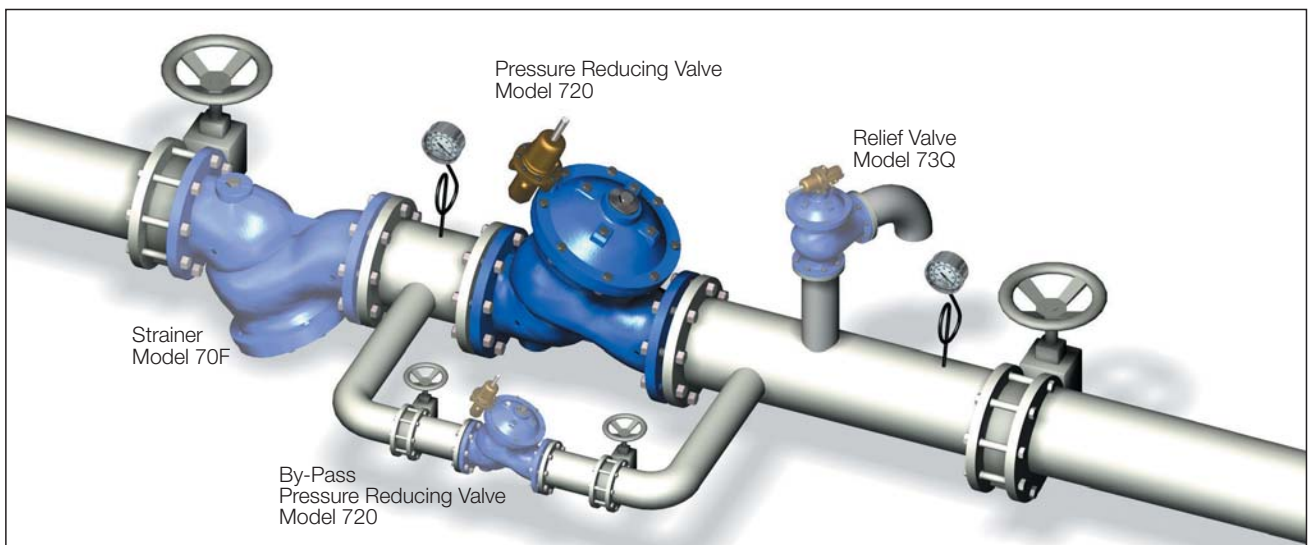

In addition to the **Model 720 Pressure Reducing Valve**, BERMAD recommends that the system also include:

- **Strainer Model 70F** prevents debris from damaging valve operation
- **Relief Valve Model 73Q** provides:
 - Protection against momentary pressure peaks
 - Visual indication of need for maintenance
- **By-Pass Pressure Reducing Valve** saves on maintenance costs. The larger (more costly to maintain) valve operates during peak demand. The smaller by-pass valve cuts operating hours of the larger valve, achieving greater return on investment.

For high differential pressure systems, see BERMAD publication 720-PD Proportional Pressure Reducing Valve.

For high pressure systems, see BERMAD publication 820 Piston Actuated Pressure Reducing Valve.

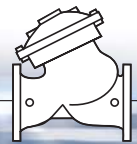

Pressure Reducing Systems in High-Rise Buildings

Water supply system design requirements for high-rise buildings present unique issues:

- Supply cut-off is unacceptable and single source supply is common.
- Valves are located in areas where water damage can be extremely expensive.
- Pressure reducing systems are often located next to prestigious residential and office space. Extraneous noise and maintenance activities are to be avoided.
- The main supply line of high-rise buildings is exposed to greater head at lower zones while pressure for the consumer must be kept within recommended levels. As a result, lower zone pressure reducing systems deal with greater differential pressure.

The **Model 720 Pressure Reducing Valves** together with BERMAD'S accumulated experience address these issues and provide appropriate solutions.

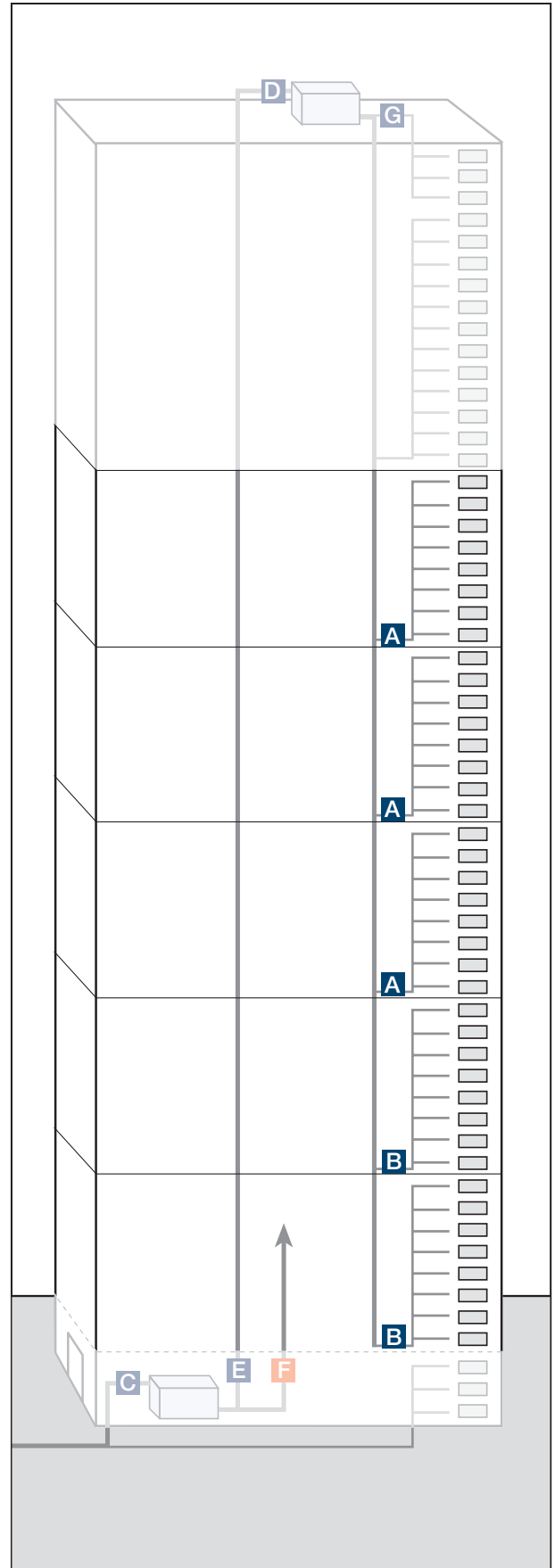

- A** Higher zone pressure reducing system installation
- B** Lower zone pressure reducing system (two-stage) installation
- C** Bottom reservoir level control system
- D** Roof reservoir level control system
- E** Potable water pumping system
- F** Fire protection pumping system
- G** Upper floors pumping system



Higher Zone Installation **A**

In addition to the municipal pressure reducing system for a high-rise building, BERMAD recommends the system also include:

- **Parallel Redundant Branches** ensuring uninterrupted supply by enabling unskilled personnel to temporarily shut off one of the branches.
- **Emergency System** including a downstream pressure switch and an Emergency Valve Model 720-PD-59.
 - **Pressure Switch [6]** signals a control panel of excessive downstream pressure.
 - **Emergency Valve [2]** is fully open during normal operation. Triggered by the control panel, it becomes a proportional pressure reducing valve.

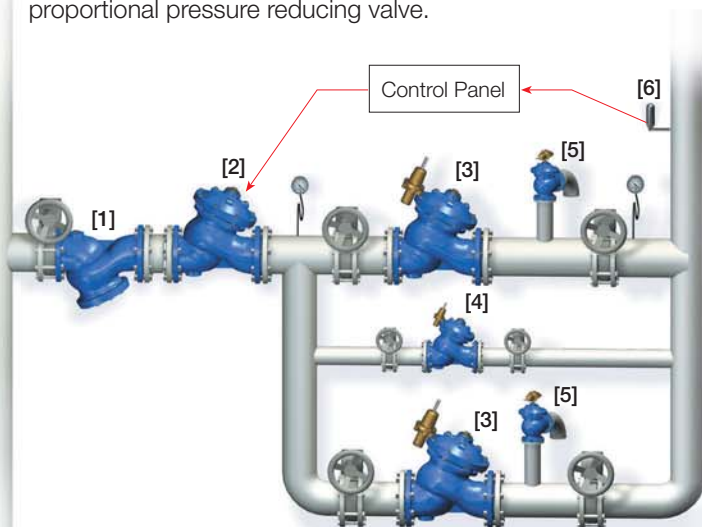

- [1] Strainer Model 70F
- [2] Emergency Pressure Reducing Valve Model 720-PD-59
- [3] Pressure Reducing Valve Model 720
- [4] By-pass Pressure Reducing Valve Model 720
- [5] Relief Valve Model 73Q
- [6] Pressure Switch

Lower Zone (Two-Stage) Installation **B**

When dealing with high differential pressure systems in lower zones of a high-rise building, BERMAD recommends a two-stage pressure reducing system. In addition to the typical higher zone installation, this high differential pressure system also includes:

- **Proportional Pressure Reducing Valve Model 720-PD**, as the first pressure reducing stage, absorbs part of the high differential pressure. By spreading the load of pressure reducing onto two components, cavitation damage and noise are reduced.

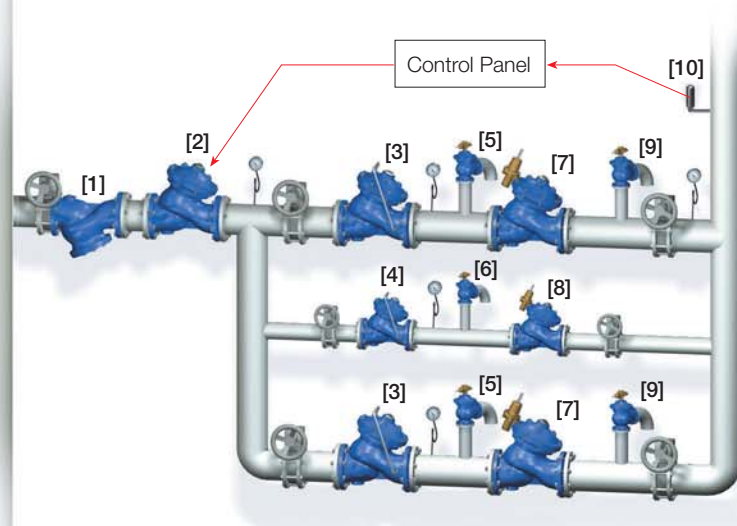

- [1] Strainer Model 70F
- [2] Emergency Pressure Reducing Valve Model 720-PD-59
- [3] Proportional Pressure Reducing Valve Model 720-PD
- [4] By-Pass Proportional Pressure Reducing Valve Model 720-PD
- [5] Primary Relief Valve Model 73Q
- [6] By-Pass Relief Valve Model 73Q
- [7] Pressure Reducing Valve Model 720
- [8] By-Pass Pressure Reducing Valve Model 720
- [9] Relief Valve Model 73Q
- [10] Pressure Switch

For high differential pressure systems, see BERMAD publication 720-PD Proportional Pressure Reducing Valve.
For high pressure systems, see BERMAD publication 820 Piston Actuated Pressure Reducing Valve.



700 Series Model 720

Technical Data

Dimensions and Weights

Size	A, B	C	L	H	Weight	
mm inch	mm inch	mm inch	mm inch	mm inch	kg lbs	
40	1 1/2"	350 14	180 7	205 8.1	239 9.4	9.1 20
50	2	350 14	180 7	210 8.3	244 9.6	10.6 23
65	2 1/2"	350 14	180 7	222 8.7	257 10.1	13 29
80	3"	370 15	230 9	250 9.8	305 12.0	22 49
100	4"	395 16	275 11	320 12.6	366 14.4	37 82
150	6"	430 17	385 15	415 16.3	492 19.4	75 165
200	8"	475 19	460 18	500 19.7	584 23.0	125 276
250	10"	520 21	580 23	605 23.8	724 28.5	217 478
300	12"	545 22	685 27	725 28.5	840 33.1	370 816
350	14"	545 22	685 27	733 28.9	866 34.1	381 840
400	16"	645 26	965 38	990 39.0	1108 43.6	846 1865
450	18"	645 26	965 38	1000 39.4	1127 44.4	945 2083
500	20"	645 26	965 38	1100 43.3	1167 45.9	962 2121

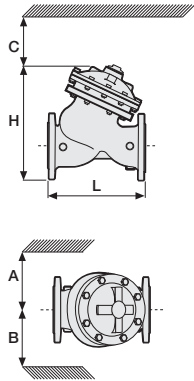

Data is for Y-pattern, flanged, PN16 valves
 Weight is for PN16 basic valves
 "C" enables removing the actuator in one unit
 "L", ISO standard lengths available
 For more dimensions and weights tables, refer to Engineering Section

Flow Chart

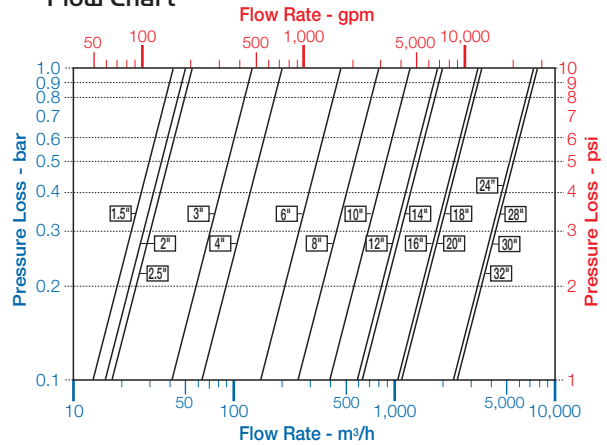

Data is for Y-pattern, flat disk valves
 For more flow charts, refer to Engineering Section

Main Valve

Valve Patterns: "Y" (globe) & angle
Size Range: 1 1/2"-32" (40-800 mm)
End Connections (Pressure Ratings):
Flanged: ISO PN16, PN25 (ANSI Class 150, 300)
Threaded: BSP or NPT
Others: Available on request
Working Temperature:
 Water up to 80°C (180°F)
Standard Materials:
Body & Actuator: Ductile Iron
Internals:
 Stainless Steel, Bronze & coated Steel
Diaphragm:
 NBR Nylon fabric-reinforced
Seals: NBR
Coating:
 Fusion Bonded Epoxy, RAL 5005 (Blue)
 NSF & WRAS approved or Electrostatic
 Polyester Powder, RAL 6017 (Green)

Control System

Standard Materials:
Accessories:
 Bronze, Brass, Stainless Steel & NBR
Tubing: Copper or Stainless Steel
Fittings: Forged Brass or Stainless Steel
Pilot Standard Materials:
Body: Brass, Bronze or Stainless Steel
Elastomers: NBR
Springs: Galvanized Steel or Stainless Steel
Internals: Stainless Steel

Pilot Valve Selection

Valve Size	Pilot Setting (bar)	Pilot Type		
		#2PB	#2	#2HC
1 1/2-10"	<15	■	●	
40-250 mm	>15			
6-14"	<15		■	
150-350 mm	>15		●	
16-32"	<15			■
400-800 mm	>15			●

■ Standard model ● with high pressure setting kit

How to Order

Please specify the requested valve in the following sequence: (for more options, refer to Ordering Guide)

Sector	Size	Primary Feature	Additional Feature	Pattern	Body Material	End Connections	Coating	Voltage & Position	Tubing & Fittings	Additional Attributes
WW	6"	720	00	Y	C	16	EB	-	CB	VI
Waterworks	1 1/2 - 32"	Pressure Reducing		Oblique (up to 20") Angle (up to 18") Globe (24-32" only)	Y A G	Epoxy FB Blue Polyester Green Polyester Blue Uncoated	EB PG PB UC		Copper Tubing & Brass Fittings Plastic Tubing & Brass Fittings St. St. 316 Tubing & Fittings	CB PB NN
No Additional Feature			00		Ductile Iron Standard				Valve Position Indicator	I
Closing and Opening Speed Control			03		Cast Steel				V-Port Throttling Plug	V
Automatic Regulation Override			09		St. Steel 316				Large Control Filter	F
High sensitivity pilot			12		Nickel Alumin. Bronze				Electric Limit Switch	S
Check Valve			20						3-Way Control Loop	X
Solenoid Controlled & Check Valve			25		ISO-16	16	24VAC/50Hz - N.C.	4AC	Valve Position Transmitter	Q
Multi-Setting Levels - Electrically Selected			45		ISO-25	25	24VAC/50Hz - N.O.	4AO	St. St. 316 Control Accessories	N
Downstream Over Pressure Guard			48		ANSI-150	A5	24VDC - N.C.	4DC	St. St. 316 Internal Trim (Closure & Seat)	T
Hydraulic Control			50		ANSI-300	A3	24VDC - N.O.	4DO	St. St. 316 Actuator Internal Assembly	D
Solenoid Controlled			55		JIS-16	J6	24VDC - L.P.	4DP	Delrin Bearing	R
Electric Override			59		JIS-20	J2	220VAC/50-60Hz N.C.	2AC	Viton Elastomers for Seals & Diaphragm	E
							220VAC/50-60Hz N.O.	2AO	Pressure Gauge	6

Multiple choices permitted

