

Flow Measurement

SITRANS F US Clamp-on

SITRANS FUP1010 (Portable)

Overview

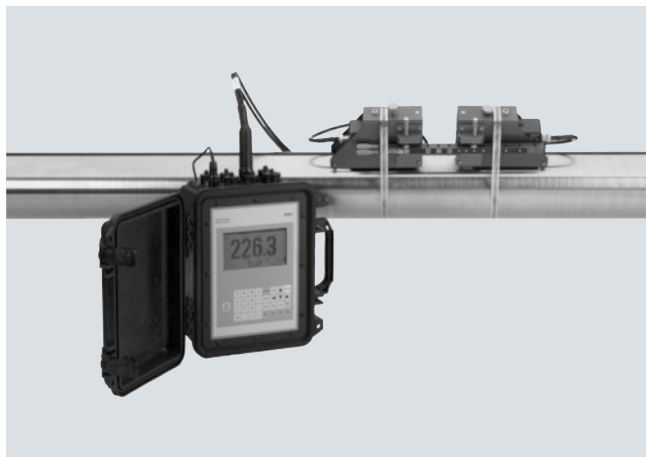

SITRANS FUP1010 clamp-on non-intrusive ultrasonic flow transmitter offers maximum versatility plus battery power for portable field use. It can operate in either WideBeam transit time or reflexor (Doppler) mode, making it suitable for virtually any liquid, even those with high aeration or suspended solids.

SITRANS FUP1010 is available in single and dual channel or dual path configurations, with IP67 weatherproof enclosure.

Benefits

- Battery power facilitates field use; the meter is easily transported from one installation to another – saving time for surveys, monitoring and temporary installations
- Weatherproof enclosure can be used outdoors and left in place without concern for rain damage
- Rugged plastic case enables it to withstand rough treatment that would destroy most other meters
- Versatility - there is no need to change meters when operating conditions change
- Easy installation; no need to cut pipe or stop flow
- Minimal maintenance; external sensors do not require periodic cleaning
- No moving parts to wear or foul
- No pressure drop or energy loss
- Wide turn-down ratio
- Choice of single or dual channel models minimizes total cost
- ZeroMatic Path automatically sets zero without stopping flow and reduces zero drift, even at low flow
- Note that the SITRANS FUP1010 flow transmitter is not available with hazardous area approvals

Application

SITRANS FUP1010 is suitable for a wide variety of liquid applications, including the following:

- Water industry
 - Raw water
 - Potable water
 - Chemicals
- Wastewater industry
 - Raw sewage
 - Effluent
 - Sludges
 - Mixed liquor
 - Chemicals
- HVAC industry
 - Chillers
 - Condensers
 - Hot and cold water systems
 - Thermal energy rate and total
- Power industry
 - Nuclear
 - Fossil
 - Hydroelectric
- Processing industry
 - Process control
 - Batching
 - Rate indication
 - Volumetric and mass measurement

Design

- IP67 Weatherproof / Impact resistant enclosure constructed of mineral reinforced copolymer polypropylene
 - Single channel
 - Dual channel / dual path

Function

- Integral 33 button keypad and large (128 x 240 pixel) graphic display visible up to 12 m (40 ft) away
- Current, voltage, frequency and RS232 outputs (see specification section for details)
- Optional current, voltage and temperature inputs (see specification section for details)
- ZeroMatic Path automatically sets zero
- Bi-directional flow operation
- 1 MByte data logger with both site and data logger storage
- English, Spanish, German, Italian and French language options

Technical specifications

Input	
Flow range	± 12 m/s (± 40 ft/s), bidirectional
Pipe size	6.4 mm ... 9.14 m (0.25" ... 360")
Inputs, single channel	<ul style="list-style-type: none"> • Current: 2 x 4 ... 20 mA DC • Voltage: 2 x 0 ... 10 V DC • Temperature: 2 x 4 wire 1 kΩ RTD
Output	
Outputs	<ul style="list-style-type: none"> • Current: 2 x 4 ... 20 mA DC (1 kΩ at 30 V DC) • Voltage: 2 x 0 ... 10 V DC (5 kΩ minimum) • Status Alarm: 4 x SPDT Relays • Frequency: 2 x 0 ... 5000 Hz • RS232
Accuracy	
Accuracy	± 0.5 % ... 2 % of flow, for velocities greater than 0.3 m/s (1 ft/s) ± 0.0015 ... 0.006 m/s (± 0.005 ... 0.02 ft/s), for velocities less than 0.3 m/s (1 ft/s)
Batch repeatability	± 0.15 % of flow, for velocities greater than 0.3 m/s (1 ft/s) ± 0.0005 m/s (± 0.0015 ft/s), for velocities less than 0.3 m/s (1 ft/s)
Rated operation conditions	
Degree of protection	<ul style="list-style-type: none"> • Weatherproof/impact resistant • IP67
Liquid temperature	<ul style="list-style-type: none"> • Standard: -40 ... +120 °C (-40 ... +250 °F) • Optional: -40 ... +230 °C (-40 ... +450 °F)
Ambient temperature	-18 ... +60 °C (0 ... 140 °F)
Design	
Dimensions	see SITRANS F US Clamp-on "System info and selection guide"
Weight	see diagrams
Power supply	
Power	Internal rechargeable battery
Battery operation	7 hours
Indication and operation	
Data logger memory	1 MByte
Site storage memory	50 sites minimum
Display	128 x 240 pixel LCD with back-light
Keypad	33 keypad buttons with tactile feedback
Language options	English, Spanish, German, Italian, French
Certificates and approvals	
Unclassified locations	UL ULc
Classified locations	
CE	EMC Directive 2004/108/EC ATEX Directive 94/9/EC

Flow Measurement SITRANS F US Clamp-on

SITRANS FUP1010 (Portable)

Standard MLFB for quick delivery on SITRANS FUP1010 Portable (excluding energy)

4

Selection and Ordering data	Order No.	Order Code
SITRANS FUP1010 (Portable)		
• IP67 weatherproof battery powered	L)	7ME3510-
		■ ■ ■ ■ - 0 ■ ■ ■ ■
Number of channels/ultrasonic paths		
Single channel	1	
Dual channel/Dual path	2	
Standard flowmeter types and I/O configurations		
• Standard I/O		C
- 2 x 4 ... 20 mA analog in		
- 2 x RTD input		
Sensor cables		
No sensor cable		A
1 x PVC Jacket cable, length 6 m/20 ft		B
2 x PVC Jacket cable, length 6 m/20 ft		C
1 x PVC Jacket cable, length 15 m/50 ft		D
2 x PVC Jacket cable, length 15 m/50 ft		E
RTD temperature Sensor (Mounting hardware & cable included)		
No RTDs	0	
1 x standard clamp-on RTD, 6 m/20 ft cable	5	
2 x standard clamp-on RTD with 6 m/20 ft cable	6	
1 x standard clamp-on RTD with 15 m/50 ft cable	7	
2 x standard clamp-on RTD with 15 m/50 ft cable	8	
Battery charger options		
No battery charger	0	
Charger Type A for Europe (CEE7/7)	1	
Charger Type G for U.S. (NEMA 5-15P)	5	
Sensor for channel 1 (includes pipe mounting kit and spacer bar for indicated max. outer diameter listed) See "Sensor selection charts" for specifications.		
no sensor		A
A2 universal Trackmount and straps provided up to 75 mm (3")		B
B3 universal Trackmount and straps provided up to 125 mm (5")		C
C3 universal Mounting frame and straps provided up to 300 mm (13")		D
D3 universal Mounting frame and straps provided up to 600 mm (24")		E
E2 universal Mounting frame and straps provided up to 600 mm (24")		F
C1H (high precision) Mounting frame and straps provided up to 600 mm (24")		M
C2H (high precision) Mounting frame and straps provided up to 600 mm (24")		N
D1H (high precision) Mounting frame and straps provided up to 600 mm (24")		P
D4H (high precision) Mounting frame and straps provided up to 600 mm (24")		R
Doppler to 12" with strap kit (not for IP65 (NEMA 7))		S
D1H High temperature range 104 °C/ 220 °F HP ²⁾		Z P 1 P

Selection and Ordering data	Order No.	Order Code
SITRANS FUP1010 (Portable)		
• IP67 weatherproof battery powered	L)	7ME3510-
		■ ■ ■ ■ - 0 ■ ■ ■ ■
Sensor for channel 2 (includes pipe mounting kit and spacer bar for indicated max. outer diameter listed) See "Sensor selection charts" for specifications.		
no sensor		A
A2 universal Trackmount and straps provided up to 75 mm (3")		B
B3 universal Trackmount and straps provided up to 125 mm (5")		C
C3 universal Mounting frame and straps provided up to 300 mm (13")		D
D3 universal Mounting frame and straps provided up to 600 mm (24")		E
E2 universal Mounting frame and straps provided up to 600 mm (24")		F
C1H (high precision) Mounting frame and straps provided up to 600 mm (24")		M
C2H (high precision) Mounting frame and straps provided up to 600 mm (24")		N
D1H (high precision) Mounting frame and straps provided up to 600 mm (24")		P
D2H (high precision) Mounting frame and straps provided up to 600 mm (24")		Q
Doppler to 12" with strap kit (not for IP65 (NEMA 7))		S
D1H High temperature range 104 °C / 220 °F HP ²⁾		Z Q 1 P
Approvals: No options (UL, ULc, CE by default)		
Standard MLFB product offering represents 4 to 6 weeks delivery time		
L) Subject to export regulations AL: N, ECCN: 3A991X		

Flow Measurement

SITRANS F US Clamp-on

SITRANS FUP1010 (Portable)

Selection and Ordering data	Order code
Further designs	
Please add "-Z" to Order No. and specify Order code(s).	
Languages (Meter and Documentation), English (default). All languages now come standard in all flow-meters	
Wet flow transfer calibration (priced on request)	
6 point calibration 2/water (Price per channel)	
<ul style="list-style-type: none"> • 2SS40 pipe • 3CS40 pipe • 4CS40 pipe • 4SS40 pipe • 6CS40 pipe • 6SS40 pipe • 6CS120 pipe • 8CS40 pipe • 8SS40 pipe • 8CS120 pipe • 10CS Standard pipe • 10CS40 pipe • 10SS40 pipe • 12CS Standard pipe • 12CS40 pipe • 14CS30 pipe • 14CS40 pipe • 16CS Standard pipe • 16CS40 pipe • 18CS Standard pipe • 20CS20 pipe • 20CS30 pipe • 24CS Standard pipe • 24CS20 pipe • 24CS30 pipe • 30CS Standard pipe • 36CS Standard pipe • Other pipe, other liquid, additional points, witness 	D01 D02 D03 D04 D05 D06 D07 D08 D09 D10 D11 D12 D13 D14 D15 D16 D17 D18 D19 D20 D21 D22 D23 D24 D25 D26 D27 Y28
1x Insertion RTD with thermowell and lagging	M1A
2x Insertion RTD with thermowell and lagging	M1B
Tag name plate	
<ul style="list-style-type: none"> • Stainless steel tag with 3.2 mm (0.13 inch) character size (68 characters max.) 	Y19

1) Supplied spacer bar supports pipes up to 1050 mm (42 inches). For pipes larger than 1050 mm (42 inches) purchase also, spare part 7ME3960-0MS40 (1012BN-4).

2) Supplied spacer bar supports pipes up to 750 mm (30 inches). For pipes larger than 750 mm (30 inches) purchase also, spare part 7ME3960-0MS40 (1012BN-4).

MLFB example

Application example

A general survey portable flowmeter is required for pipes sizes ranging from 76 ... 500 mm (3" ... 20") with both cast iron and steel material. Doppler may be required as liquid may be moderately aerated.

Requires language support for German.

MLFB Order No.: **7ME3511-2AB01-0DE0-Z B10**

Selection and Ordering data	Order No.	Ord. code
SITRANS FUP1010 meter family	7ME3511-2AB01-0DE0-Z B10	
IP67 weatherproof	1	
Dual channel	2	
Portable Type 3 I/O with Doppler capable, temperature	C	
1 x PVC-Jacket, length 6 m (20 ft)	B	
No RTDs required	0	
Charger Type A for Europe (CEE7/7)	1	
Sensor for DN 50 ... DN 300 (2" ... 12") pipes	D	
Sensor for DN 200 ... DN 600 (8" ... 24") pipes	E	
German language support		B10

Universal sensor selection chart

Based on pipe size (pipes other than steel)









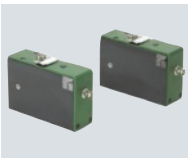

Pipe size	Order Code	Outer diameter range (mm)		Outer diameter range (inches)	
		min.	max.	min.	max.
A2	B	12,7	50,8	0,5	2
B3	C	19	127	0,75	5
C3	D	51	305	2	12
D3	E	203	610	8	24
E2	F	254	6096	10	249

High precision sensor selection chart

Based on pipe wall thickness (steel pipes only)

Pipe Wall	Order Code	Pipe Wall [mm]		Pipe Wall [inches]	
		min.	max.	min.	max.
A1H	G	0,64	1,02	0,025	0,04
A2H	H	1,02	1,52	0,04	0,06
A3H	J	1,52	2,03	0,06	0,08
B1H	K	2,03	3,05	0,08	0,12
B2H	L	3,05	4,06	0,12	0,16
C1H	M	4,06	5,84	0,16	0,23
C2H	N	5,84	8,13	0,23	0,32
D1H	P	8,13	11,18	0,32	0,44
D2H	Q	11,18	15,75	0,44	0,62
D4H	R	15,75	31,75	0,62	1,25







Accessories/Spare parts for clamp-on ultrasonic flowmeters



Description	Order No.		Description	Order No.	
Universal Portable Sensors Selected generally for portable systems where a wide variety of pipes are to be measured. Since they are selected based on diameter only, a wide range of pipe sizes and materials can be covered with a minimum number of sensors. These can also be selected as a cost savings on applications where standard accuracy is sufficient.	D) 7ME3951-...		Mounting Frames These items are useful in simplifying sensor installation. They are strapped to the pipe first then the sensors are installed, making the installation less cumbersome and more precise. They also enable easy repeated mounting of the sensors assuring conformation to the original sensor positioning. They may be left in place at each measurement location where periodic flow surveys are conducted to simplify subsequent installations and ensure repeatable results.	D) 7ME3960-...	
High Precision Sensors Selected generally for dedicated meters since the need to cover a range of pipes is not a requirement. They provide the highest accuracy achievable by the meters and therefore should be selected whenever higher accuracy/repeatability is required. They are only applicable to steel pipes but no other metals, and are selected solely by wall thickness.	D) 7ME3950-...		Spacer Bars Sensors are required to be mounted at a set distance from each other as determined by pipe size and medium being measured. The spacer bar simplifies this requirement by eliminating the need to undertake a precise dimensional measurement. The flowmeter will specify a specific spacing index which is easily accommodated with the marked indices on the bar.	D) 7ME3960-...	
High Temperature Sensors Are selected whenever pipe temperature will exceed 250 °F (120 °C) up to a maximum of 450 °F (232 °C). They are universal type and can therefore be used on any pipe material and are selected by pipe diameter.	D) 7ME3950-...		Clamp-On RTD's 1000 Ω platinum RTD's for use where temperature is required. Used with Energy Meters to record supply/return temperature. For this purpose precision matched pairs (to 0.02 °C) are supplied. Single RTD's are also used with SITRANS FUH and SITRANS FUG meters to enable live calculations of "Liquid" and Standard Volume Correction.	D) 7ME3950-...	
Weld Seal Mount These provide the most secure and strongest mounting of the flow sensors. They are generally selected for "High End" meter types where maximum performance criteria applies. They accommodate high precision sensors designed to mount inside these enclosures. May be welded to the pipe if so desired by the customer. They come in 2-piece or 1-piece configurations depending upon the application pipe size and type (Liquid/Gas).	D) 7ME3960-...		Insert RTD's Are identical to clamp-on RTD's as described above except that they are inserted into the pipe (In a Thermowell). They provide more precise and quicker responding temperature measurement. They are selected when precise temperature measurement of the actual liquid or gas is required as opposed to pipe "skin temperature". Since they project into the pipe they cannot be used in pipeline that undergo periodic "pigging".	D) 7ME3950-...	
Mounting tracks Typically used on smaller pipes for easier and more stable mounting for dedicated universal style sensor size A or B, also available for dedicated high precision sensor size A or B.	D) 7ME3960-...		Standard Cable (Flow Sensor or RTD) Selected for general purpose installations where no special application requirements exist.	D) 7ME3960-...	
			Submersible Cable (Flow Sensor) Polyethylene jacketed, for locations that experience periodic or continual submersion of the flow sensors.	D) 7ME3960-...	

Flow Measurement

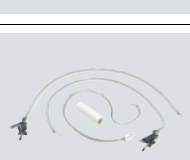
SITRANS F US Clamp-on

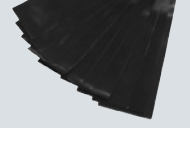
Accessories/Spare parts

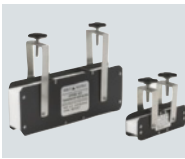
Description	Order No.	
Plenum Cable (Flow Sensor or RTD) For temperatures above 180 °F. Teflon jacketed to withstand high temperatures, is used when high temp sensors are specified.	D) 7ME3960-...	
Armored Cable (Flow Sensor) Double shielded cable, selected when cable will not be installed in conduit between meter and sensors.	D) 7ME3960-...	
Temperature sensor cable Cable to connect field installed RTD to flow meter, available in Teflon wrapped, plenum or submersible grade. Typically used for SITRANS FUE, FUH and FUG series meters where a temperature sensor is employed.	D) 7ME3960-...	
Straps Used to fasten sensors or mounting frames to pipe for dedicated meter installations. Stainless steel construction for corrosion resistance.	D) 7ME3960-...	
Chains (EZ clamps) Used to fasten portable sensors or mounting frames to pipe. Thumbscrews eliminate need for hand tools when mounting sensors, and allow for easy on/off operations.	D) 7ME3960-...	
Ultrasonic Couplant Fills any voids between sensor emitting surface and pipe wall to allow maximum energy transfer between sensor and pipe. Several different types of couplants are employed as determined by the application conditions and type of installation (Temporary or permanent).	D) 7ME3960-...	
Dry Couplant The dry coupling pad is intended for use in any liquid, clamp-on transit time or Doppler applications that require a more durable coupling material. Installation is easy by simply placing one strip of material between sensor and pipe. Not intended for clamp-on gas where damping material is used. The temperature range is -34 to +200 °C (-30 to +392 °F).	D) 7ME3960-...	
Damping Material Used with gas meters, and required as part of their sensor installation. This material absorbs excess ultrasonic energy from the pipe wall to enable the meter to detect and operate with low amplitude sensor signals normally associated with Clamp-on Gas applications.	D) 7ME3960-...	

Description	Order No.	
Test Block Used for checking operation of a meter and sensors prior to a field installation, or as a troubleshooting tool. Selected by sensor size, each block accommodates 2 sensor sizes. Available only for universal sensors.	D) 7ME3960-...	
Termination Kit (Flow Sensor or RTD) Provides the connectors, labels and shrink tubing or other associated hardware to complete the termination of a specific cable type. These can be provided in cases where users will be purchasing bulk cable directly and cutting to length at their site, or when existing cable length is to be altered. Selected by cable type.	D) 7ME3960-...	

Selection and Ordering data	Order No.
<i>Spare parts (System)</i>	
SITRANS F US clamp-on	7ME 3 9 4 0 -
Power supplies, batteries and chargers	
Power supply 90 ... 240 V AC	
• for IP65 (NEMA 4X) wall mount or IP66 (NEMA 7) wall mount explosionproof	D) 0 PA 0 0
• for IP65 (NEMA 7) compact explosionproof	D) 2 PA 0 0
Power supply 9 ... 36 V DC	
• for IP65 (NEMA 4X) wall mount or IP66 (NEMA7) wall mount explosionproof	K) 0 PB 0 0
• negative ground for NEMA 7 compact explosionproof	D) 2 PJ 0 0
• positive ground for NEMA 7 compact explosionproof	D) 2 PK 0 0
Portable meter batteries and accessories	
• Internal battery (Portable meters only)	D) 3 PP 0 0
IP67 Portable meter charger	
• Type A for Europe (CEE7/7)	D) 3 PC 0 0
• Type C for Australia (AS3112)	D) 3 PD 0 0
• Type D for UK (BS1363)	D) 3 PE 0 0
• Type J for Japan (JIS8303)	D) 3 PF 0 0
• Type K for US (NEMA 5-15P)	D) 3 PG 0 0
• Type L for Switzerland (SEV1011)	D) 3 PH 0 0
IP40 Portable meter charger	
• Type A for Europe (CEE7/7)	D) 4 PC 0 0
• Type C for Australia (AS3112)	D) 4 PD 0 0
• Type D for UK (BS1363)	D) 4 PE 0 0
• Type J for Japan (JIS8303)	D) 4 PF 0 0
• Type K for US (NEMA 5-15P)	D) 4 PG 0 0
• Type L for Switzerland (SEV1011)	D) 4 PH 0 0
MODBUS system computer modules	
MODBUS converter module	D) CQO-1015N-5M
Mounting kit (type 1) for MODBUS converter module	D) CQO-1015N-5M-MK1
Mounting kit (type 2) for MODBUS converter module	D) CQO-1015N-5M-MK2
Mounting kit (type 3) for MODBUS converter module	D) CQO-1015N-5M-MK3
Field configuration kit with manual, for MODBUS converter module	D) CQO-1015N-5M-FK1
Pipe mounting brackets	
2 inch pipe mounting bracket for IP65 (NEMA 7) compact explosionproof	D) CQO-1012XMB-1
2 inch pipe mounting bracket for IP65 (NEMA 4X) wall mount	D) CQO-1012NMB-1

D) Subject to export regulations AL: N, ECCN: EAR99H.

K) Subject to export regulations AL: N, ECCN: 5A991X.

Flow Measurement

SITRANS F US Clamp-on

Accessories/Spare parts

Selection and Ordering data	Order No.
<i>Spare parts (Sensors)</i>	
SITRANS F US clamp-on	
Meter type	
Dedicated (SITRANS FUS1010, FUG1010, FUH1010, FUE1010)	D) 7ME3950 - ■■■■
Portable (SITRANS FUP1010 or FUE1010)	D) 7ME3951-0 ■■■■
Approvals	
UL, ULc, CE (Portable only)	0
FM/CSA hazardous (classified) locations	1
ATEX Ex II 1G Ex ia IIC T5 (not for RTDs)	2
INMETRO (not for RTDs)	3
Spare sensor code	
<u>For liquid flow sensors pipe ranges please refer to sensor selection chart in the SITRANS FUS1010 section</u>	
<u>Liquid flow sensors for use with mounting frames or tracks (including portable)</u>	
A2 universal	LB00
B3 universal	LC00
C3 universal	LD00
D3 universal	LE00
E2 universal	LF00
A1H (high precision)	LG00
A2H (high precision)	LH00
A3H (high precision)	LJ00
B1H (high precision)	LK00
B2H (high precision)	LL00
B3H (high precision)	LT00
C1H (high precision)	LM00
C2H (high precision)	LN00
D1H (high precision)	LP00
D2H (high precision)	LQ00
D3H (high precision)	LU00
D4H (high precision)	LR00
Doppler	LS00
<u>High precision liquid sensor for weld seal enclosures</u>	
C1H (high precision, weld seal)	SM00
C2H (high precision, weld seal)	SN00
D1H (high precision, weld seal)	SP00
D2H (high precision, weld seal)	SQ00
D3H (high precision, weld seal)	SU00
D4H (high precision, weld seal)	SR00

Selection and Ordering data	Order No.
<i>Spare parts (Sensors)</i>	
SITRANS F US clamp-on	
Meter type	
Dedicated (SITRANS FUS1010, FUG1010, FUH1010, FUE1010)	D) 7ME3950 - ■■■■
Portable (SITRANS FUP1010 or FUE1010)	D) 7ME3951-0 ■■■■
<u>High temperature universal liquid sensors</u>	
Note: not available with INMETRO approval	
High temp. sensor size 1 for up to 230 °C (12.7 to 100 mm diam.)	LA10
High temp. sensor size 2 for up to 230 °C (30 to 200 mm diam.)	LA20
High temp. sensor size 3 for up to 230 °C (150 to 600 diam.)	LA30
High temp. sensor size 4 for up to 230 °C (400 to 1200 diam.)	LA40
<u>For gas flow sensors pipe ranges please refer to sensor selection chart in the SITRANS FUG1010 section</u>	
<u>High precision gas flow sensors for use with mounting frames or tracks</u>	
B1H (high precision)	GK00
B2H (high precision)	GL00
B3H (high precision)	GT00
C1H (high precision)	GM00
C2H (high precision)	GN00
D1H (high precision)	GP00
D2H (high precision)	GQ00
D3H (high precision)	GU00
D4H (high precision)	GR00
<u>High precision gas sensor for weld seal enclosures</u>	
C1H (high precision, weld seal)	HM00
C2H (high precision, weld seal)	HN00
D1H (high precision, weld seal)	HP00
D2H (high precision, weld seal)	HQ00
D3H (high precision, weld seal)	HU00
D4H (high precision, weld seal)	HR00
D) Subject to export regulations AL: N, ECCN: EAR99H	

4

Selection and Ordering data	Order No.	Selection and Ordering data	Order No.
Spare parts (Sensors)		Spare parts (Miscellaneous)	
SITRANS F US clamp-on		SITRANS F US clamp-on	D) 7ME3960 - ■■■■
Meter type		Meter design	
Dedicated (SITRANS FUS1010, FUG1010, FUH1010, FUE1010)	D) 7ME3950 - ■■■■	IP65 (NEMA 4X) wall mount or IP66 (NEMA 7) wall mount explosionproof	0
Portable (SITRANS FUP1010 or FUE1010)	D) 7ME3951 - 0 ■■■■	IP65 (NEMA 7) compact	2
<u>Standard RTD sensors (not for energy systems)</u>		IP67 weatherproof portable	3
Standard clamp-on RTD	1TA00	IP40 (NEMA 1) Portable	4
Submersible clamp-on RTD (not for Portable)	1TB00	Dedicated sensor mounting hardware	
Insertion style RTD pair (size 1), 140 mm (5.5 inch)	1TJ00	Sensor mounting tracks (aluminium with mounting straps) for pipes < 125 mm (5 inch)	
Insertion style RTD pair (size 2), 216 mm (8.5 inch)	1TJ01	• Universal sensor size A or B	0MA00
Insertion style RTD pair (size 3), 292 mm (11.5 inch)	1TJ02	• High precision sensor size A or B	0MB00
Insertion style RTD pair (size 4), 368 mm (14.5 inch)	1TJ03	Sensor mounting frames for	
<u>Standard for energy system (matched pair)</u>		• Universal sensor size B (for pipes > 125 mm (5 inch))	D) CQO-1012FN-PB
Standard clamp-on RTD	1TA10	• Universal sensor size C	0MC00
Insertion style RTD pair (size 1) for SITRANS FUE1010, 140 mm (5.5 inch)	1TJ10	• Universal sensor size D	0MC01
Insertion style RTD pair (size 2) for SITRANS FUE1010, 216 mm (8.5 inch)	1TJ11	• Universal sensor size E	0MC02
Insertion style RTD pair (size 3) for SITRANS FUE1010, 292 mm (11.5 inch)	1TJ12	• High precision sensor size B (for pipes > 125 mm (5 inch))	D) CQO-1012FNH-PB
Insertion style RTD pair (size 4) for SITRANS FUE1010, 368 mm (14.5 inch)	1TJ13	• High precision sensor size C	0MD00
1) Supplied spacer bar supports pipes up to 750 mm (30 inches). For pipes larger than 750 mm (30 inches) purchase also, spare part 7ME3960-0MS40 (1012-BN-4)		• High precision sensor size D	0MD01
D) Subject to export regulations AL: N, ECCN: EAR99H.		Mounting straps for mounting frames (slotted stainless steel)	
		• For pipes from DN 50 to DN 150	0SM00
		• For pipes from DN 50 to DN 300	0SM10
		• For pipes from DN 300 to DN 600	0SM20
		• For pipes from DN 600 to DN 1200	0SM30
		• For pipes from DN 1200 to DN 1500	0SM40
		• For pipes from DN 1500 to DN 2100	0SM50
		• For pipes from DN 2100 to DN 3000	0SM60
		Spacer bars (for indexing sensors on pipe)	
		• Spacer bars for pipes to 200 mm/8 inch (liquid), 600 mm / 24 inch (gas)	0MS10
		• Spacer bars for pipes to 500 mm/20 inch (liquid), DN 1200 / 48 inch (gas)	0MS20
		• Spacer bars for pipes to 800 mm/32 inch (liquid)	0MS30
		• Spacer bars for pipes to 1200 mm/48 inch (liquid) Only use in conjunction with 7ME3960-0MS30	0MS40
		Weld seal mounting enclosures for liquid and gas sensors	
		• Single enclosure for size C high precision	0WS20
		• Single enclosure for size D high precision	0WS30
		• Single enclosure for size E universal	0WS40
		• Dual enclosure for size C high precision	0WD20
		• Dual enclosure for size D high precision	0WD30
		• Dual enclosure for size E universal	0WD40

Flow Measurement

SITRANS F US Clamp-on

Accessories/Spare parts

Selection and Ordering data	Order No.
<i>Spare parts (Miscellaneous)</i>	
SITRANS F US clamp-on	D) 7ME3960 -
Stainless steel straps for weld seal enclosure mounting	
• Mounting strap for pipe diameter to 300 mm (13 inch)	0SM01
• Mounting strap for pipe diameter to 600 mm (24 inch)	0SM11
• Mounting strap for pipe diameter to 1200 mm (48 inch)	0SM21
• Mounting strap for pipe diameter to 1500 mm (60 inch)	0SM31
• Mounting strap for pipe diameter to 2130 mm (84 inch)	0SM41
• Mounting strap for pipe diameter to 3050 mm (120 inch)	0SM51
Stainless mounting tracks for high temp 991 sensors	
• Size 1 high temp sensor pair	D) CQO-992MTNHMSH-1
• Size 2 high temp sensor pair	D) CQO-992MTNHMSH-2
• Size 3 high temp sensor pair	D) CQO-992MTNHMSH-3
• Size 4 high temp sensor pair	D) CQO-992MTNHMSH-4
Clamp-on RTD mounting hardware for dedicated systems	
• RTD mounting hardware for dedicated system: 152 to 610 mm (6 to 24 inch)	0MR00
• RTD mounting hardware for dedicated system: 12.7 to 50.8 mm (0.5 to 2 inch)	0MR01
• RTD mounting hardware for dedicated system: 31.8 to 203.2 mm (1.25 to 8 inch)	0MR02
• RTD mounting hardware for dedicated system: 508 to 1219 mm (20 to 48 inch)	0MR04
• Junction box for clamp on RTD's	D) CQO-992ECJ
Portable sensor mounting hardware	
Sensor mounting tracks for portable sensors (aluminum with mounting chains) for pipes < 125 mm (5 inch) for	
• Universal sensor size A or B	3MA00
• High precision sensor size A or B	3MB00
Sensor mounting frames	
• Universal sensor size B (for pipes >125 mm (5 inch))	D) CQO-1012FP-PB
• Universal sensor size C	3MC00
• Universal sensor size D	3MC01
• Universal sensor size E	3MC02
• High precision sensor size B (for pipes > 125 mm (5 inch))	D) CQO-1012FPH-PB
• High precision sensor size C	3MD00
• High precision sensor size D	3MD01
Spacer bar (for indexing portable sensors)	3MS00
Mounting chain and EZ clamp hardware	
• EZ clamp hardware set for DN 25 to DN 600 (1 to 24 inch); handles all transducers except "D" size HP and "E" size univ.	D) CQO-1012Z-1
• EZ clamp hardware set for DN 25 to DN 600 (1 to 24 inch) for "D" size HP and "E" size universal	D) CQO-1012Z-2
• Mounting chain for portable sensors: 4 x 760 mm lengths	3CM10
• Mounting chain for portable sensors: 2 x 760 mm and 2 x 1500 mm lengths	3CM20

Selection and Ordering data	Order No.
<i>Spare parts (Miscellaneous)</i>	
SITRANS F US clamp-on	D) 7ME3960 -
RTD mounting hardware for portable system	3MR00
Sensor connector adaptors	
• "F" connector to BNC adapter (order 2 per sensor set)	D) CQO-1012NFPA
SITRANS FST020 Sensor trackmounts	
• Single enclosure mounting track for "A" size Xdcr pair, Reflect	D) CQO-1022A1R
• Single enclosure mounting track for "B" size Xdcr pair, Reflect	D) CQO-1022B1R
• Dual enclosure mounting track for "B" size Xdcr pair, Reflect/Direct	D) CQO-1022B2R
• Single enclosure mounting track for "C" size Xdcr pair, Reflect	D) CQO-1022C1R
• Dual enclosure mounting track for "C" size Xdcr pair, Reflect/Direct	D) CQO-1022C2R
• Dual enclosure mounting track for "D" size Xdcr pair, Reflect/Direct	D) CQO-1022D2R
D) Subject to export regulations AL: N, ECCN: EAR99H.	

Flow Measurement

SITRANS F US Clamp-on

Accessories/Spare parts

Selection and Ordering data	Order No.	Selection and Ordering data	Order No.
<i>Spare parts (Miscellaneous)</i>		<i>Spare parts (Miscellaneous)</i>	
SITRANS F US clamp-on	D) 7ME3960 -	SITRANS F US clamp-on	D) 7ME3960 -
Insert RTD Thermowells		Ultrasonic couplants	
• Thermowell std. duty uninsulated pipe 140 mm (5.5 inch)	D) CQO-1012TW-1	• Temporary water based for portable systems: 350 ml (12 oz): -34 ... +38 °C (-30 ... +100 °F)	0UC10
• Thermowell std. duty uninsulated pipe 216 mm (8.5 inch)	D) CQO-1012TW-2	• Permanent synthetic polymer based: 90 ml (3 oz) -40 ... +190 °C (-40 ... +375 °F)	0UC20
• Thermowell std. duty uninsulated pipe 292 mm (11.5 inch)	D) CQO-1012TW-3	• Permanent high temp fluoroether: 12 ml (0.4 oz): -40 ... +230 °C (-40 ... +450 °F)	0UC30
• Thermowell std. duty with lagging 140 mm (5.5 inch)	D) CQO-1012TW-1L	• Permanent high temp fluoroether: 163 ml (5.5 oz): -40 ... +230 °C (-40 ... +450 °F)	0UC50
• Thermowell std. duty with lagging 216 mm (8.5 inch)	D) CQO-1012TW-2L	• Permanent vulcanizing silicone rubber couplant: 90 ml (3 oz): -40 ... +120 °C (-40 ... +250 °F)	D) CQO-CC112
• Thermowell std. duty with lagging 292 mm (11.5 inch)	D) CQO-1012TW-3L	• Permanent high temp silicone grease: 12 ml (0.4 oz): -40 ... +230 °C (-40 ... +450 °F)	D) CQO-CC117
Sensor cables for (Use "Sensor cable selection chart" to complete Order No. with ##)		• Permanent high temp silicone grease: 150 ml (5 oz): -40 ... +230 °C (-40 ... +450 °F)	D) CQO-CC117A
• IP65 (NEMA 4X) wall mount or IP 66 (NEMA 7) wall mount explosionproof	0CK##	• Couplant for submersible sensor applications	D) CQO-CC120
• IP65 (NEMA 7) compact explosionproof	2CK##	• Dry coupling pads (qty of 10): -34 to +200 °C (-30 to +392 °F)	0UC40
• IP67 Weatherproof portable	3CK##	Pipe damping films for SITRANS FUG gas systems	
• IP40 (NEMA 1) Portable	4CK##	• B1, B2, B3, C1 and C2 sensors	0DM10
RTD cables for (Use "Sensor cable selection chart" to complete Order No. with ##)		• D1 and D3 sensors	0DM20
• All dedicated systems	0CR##	• D2 sensor	0DM30
• IP67 Weatherproof portable	3CR##	• D4 sensor	0DM40
• IP40 (NEMA 1) Portable	4CR##	Serial RS232 Cables and I/O Adapters	
Dedicated cable termination kits		• RS232 Cable for all dedicated meters	0CS00
• Standard, plenum and armored sensor cable (NEMA 4X wall mount and NEMA 7 wall mount explosionproof)	0CT01	• RS232 Cable for IP66 weatherproof portable meter	3CS00
• Submersible sensor cable (NEMA 4X wall mount and NEMA 7 wall mount explosionproof)	0CT11	• RS232 Cable for IP40 Portable meter	4CS00
• Standard and plenum sensor cable (SITRANS FST020)	1CT01	• I/O adapter for IP66 Weatherproof portable meter	3AD00
• Standard, plenum and armored sensor cable (NEMA 7 compact explosionproof)	2CT01	Universal Sensor Test Blocks	
• Submersible sensor cable (NEMA 7 compact explosionproof)	2CT11	• Test block for size A and B universal sensors	0TB10
• Clamp-on RTD cable termination kit for standard RTD	0CT21	• Test block for size C and D universal sensors	0TB20
• Clamp-on RTD cable termination kit for submersible RTD	0CT31	Field Manuals	
• Insert RTD cable termination kit	0CT41	• CD with documentation for SITRANS F US Clamp-on ultrasonic flowmeters (English)	D) A5E02830664-03

D) Subject to export regulations AL: N, ECCN: EAR99H.

Flow Measurement

SITRANS F US Clamp-on

Accessories/Spare parts

Sensor cable selection chart (Dedicated, pair)

Sensor cable codes for length and type options				
Cable length m (ft)	Standard -40...+80 °C (-40...+176 °F)	Submersible -40...+80 °C (-40...+176 °F)	Plenum -40...+200 °C (-40...+392 °F)	Armored -40...+80 °C (-40...+176 °F)
Order code				
6 (20)	K01	K11	K21	K31
15 (50)	K02	K12	K22	K32
30 (100)	K03	K13	K23	K33
46 (150)	K04	K14	K24	K34
61 (200)	K05	K15	K25	K35
91 (300)	K06	K16	K26	K36

Sensor cable selection chart (SITRANS FUP1010, FUE1010 Portable, pair)

Sensor cable codes for length and type options		
Cable length m (ft)	Standard -40 ... + 80 °C (-40 ... +176 °F)	Plenum -40 ... + 200 °C (-40 ... +392 °F)
Order Code		
6 (20)	K01	K21
15 (50)	K02	K22
30 (100)	K03	K23

RTD cable selection chart (Dedicated, each)

RTD cable codes for length and type				
Cable length m (ft)	Standard -40 ... +200 °C (-40 ... +392 °F)	Submersible -40 ... +200 °C (-40 ... +392 °F)	for insert RTD -40 ... +200 °C (-40 ... 392 °F)	for submersible insert RTD -40 ... +200 °C (-40 ... 392 °F)
Order code				
6 (20)	R01	R11	R21	R31
15 (50)	R02	R12	R22	R32
30 (100)	R03	R13	R23	R33
46 (150)	R04	R14	R24	R34
61 (200)	R05	R15	R25	R35
91 (300)	R06	R16	R26	R36

RTD cable selection chart (SITRANS FUP1010, FUE1010 Portable, each)

RTD cable codes for length and type options	
Cable length m (ft)	IP67 -40 ... + 200 °C (-40 ... +392 °F)
Order Code	
6 (20)	R11
15 (50)	R12
30 (100)	R13

Accessories - Standard MLFB offering

Description	Order No.
Insert RTD size 1	D) 7ME3950-1TJ10
Thermowell size 1 w/lagging	D) CQO:1012TW-1L
EZ Clamp 1 ... 24 inch	D) CQO:1012Z-1
Junction Box for Clamp RTD	D) CQO:992ECJ
Term kit standard, Plenum, Armored sensor cable	D) 7ME3960-0CT01
Term kit Submersible sensor cable	D) 7ME3960-0CT11
C1 Weld seal	D) 7ME3960-0WS20
D1 Weld Seal	D) 7ME3960-0WS30
C2 Weld Seal	D) 7ME3960-0WD20
D2 Weld Seal	D) 7ME3960-0WD30
Straps size 2	D) 7ME3960-0SM11
Straps size 3	D) 7ME3960-0SM21
Straps size 4	D) 7ME3960-0SM31
Weld seal sensors C2 FM	D) 7ME3950-1SN00
Weld seal sensors D1 FM	D) 7ME3950-1SP00
Weld seal sensors D2 FM	D) 7ME3950-1SQ00
Weld seal sensors D4 FM	D) 7ME3950-1SR00
Weld seal sensors C2 ATEX	D) 7ME3950-2SN00
Weld seal sensors D1 ATEX	D) 7ME3950-2SP00
Weld seal sensors D2 ATEX	D) 7ME3950-2SQ00
Weld seal sensors D4 ATEX	D) 7ME3950-2SR00
Weld seal sensors Gas C2 FM	D) 7ME3950-1HN00
Weld seal sensors Gas D1 FM	D) 7ME3950-1HP00
Weld seal sensors Gas D2 FM	D) 7ME3950-1HQ00
Weld seal sensors Gas D4 FM	D) 7ME3950-1HR00
Weld seal sensors Gas C2 ATEX	D) 7ME3950-2HN00
Weld seal sensors Gas D1 ATEX	D) 7ME3950-2HP00
Weld seal sensors Gas D2 ATEX	D) 7ME3950-2HQ00
Weld seal sensors Gas D4 ATEX	D) 7ME3950-2HR00

Standard MLFB product offering represents 4 to 6 weeks delivery time.

D) Subject to export regulations AL: N, ECCN: EAR99H.